

Black Opal R12 R Series Flat Panel Display System



TABLE OF CONTENTS

Chapter	Page
1 DESCRIPTION	1-1
2 SPECIFICATIONS	2-1
2.1 System Performance	2-1
2.2 Communications	2-3
2.3 Physical Characteristics	2-3
2.4 Electrical Characteristics	2-3
2.5 Environmental	2-3
2.6 Connector/Pin Details	2-4
2.7 Embedded Customer Specified Circuits	2-6
3 SET-UP	3-1
3.1 Mounts	3-1
3.2 Connections	3-2
3.3 Set-up Procedure	3-2
3.4 Heating and Cooling	3-3
4 OUTLINE DRAWING	4-1
LIST OF FIGURES	
Figure 3-1: Mounts	3-1
Figure 3-2: Connections	3-2
Figure 4-1: Outline Drawing	4-1



Black Opal R12 R Series Flat Panel Display System

1 DESCRIPTION

The R12 model series is an XGA resolution, 12.1" member of the Black Opal display family. Within this series, both standard and fully customised models are available, designed for use in fixed or vehicle mounted surveillance systems. All Laserdyne Black Opal displays have been engineered for a wide range of land-, sea- or air-borne display applications including remote/indirect viewing of video images generated by day, night or thermal cameras.

A standard feature of all R12 models is the ruggedization and advanced video processing features for which Black Opal displays are renowned. Multiple standard-definition inputs are also standard across the range. As a factory-fit option, the R12 can include an internal **Digital Video Recorder** that has removable USB 2.0 media, with recorded video content immediately available in a standard mp4 format, as well as event snapshots. Another factory-fit option is a current generation **fan-less Intel x86 Processor with touch-screen**. Both options can create cost savings elsewhere in a vehicle by integrating mission equipment like user interfaces for equipment control, BMS, moving map or similar.

To provide Outdoor Readability the R12 is fitted with a full sunlight readable high brightness LCD (with LED backlight). The R12 screen may be viewed in full direct sunlight to full darkness. Two Night Vision compatible backlights are equipped as a standard feature; NVIS Green to satisfy MIL-STD-3009, and a NVIS Red mode that is compatible with dark-adapted vision for covert use in the extreme dark.

The LCD is optically bonded to a tough, laminated, EMI shielded, antireflection treated window, that can include an optional touch-screen. LCD Heater technology ensures operation of the LCD screen at low temperatures with no degradation of image quality, and no fogging. The two-part chassis is manufactured from solid aluminium billets and finished to be tough and scratch resistant, as well as being a heat sink to aid high temperature operation, and for EMC compliance. The R12 has low mass to support airborne applications.

State of the art real time video processing in an FPGA processor provides video display with ultra-low video latency for operator comfort under all operational scenarios. Black Opal displays also have several features designed to increase the effectiveness of surveillance, sighting and security systems, including:

Image Enhancement: video inputs are compensated for obscuration (e.g. rain, fog, snow, mist or smoke) or low contrast using a proprietary low-latency maximum-entropy image enhancer, operational within an adjustable central window where contrast and colour are enhanced.

Digital Zoom: a fully X & Y interpolated zoom;

Freeze Frame: freezes the current prime video channel while leaving live any video inset.

Colourisation: applies preloaded colour palettes to monochrome imagery.

Motion ("edge tearing") compensation: minimises the jagged edges that can occur with motion from interlaced sources.

Multiple Video Window 'layouts' supported, including splits and quad.

The Low Cost R12 Series of displays is a platform for **customisation**, even for small volumes of display. While SD inputs (PAL, NTSC) are standard in the range, almost any video input/output standard/type/connection is available, including SDI, DVI/HDMI, VGA, etc, as well as streaming sources over IP. The number of buttons, position, connector type, count and orientation as well as all aspects of the mechanical chassis can be customised to any application. ARM and x86 computer integrations are available, and where they are not appropriate Laserdyne can develop a solution, or allow a customer to integrate their own circuit design as one of two daughter card form factors.

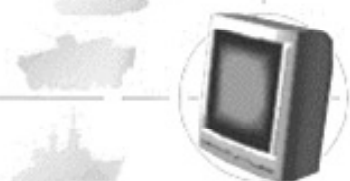

Black Opal R12 R Series Flat Panel Display System

2 SYSTEM SPECIFICATIONS

Notation - use of brackets in tables: [notes & qualifications] (units) {alternate units}.

2.1 System Performance

PARAMETER		SPECIFICATION
Designation		
R12 series		Black Opal 12.1", high brightness, XGA resolution
Control		
Control Functions [factory configurable to customer requirements]		On/Off; NVIS mode; backlight intensity; image controls. All other buttons are soft controlled by an embedded MCU.
Controls		21 tactile LED-backlit (green or red selectable) buttons. <i>Other button arrangements and/or other user controls available on request. Touch screen also available on request.</i>
Display		
Type		Active Matrix Colour (24-bit colour) LED backlit LCD Module
Display Size (" {cm})	diagonal	12.1 {30.73}
	active area	9.7 {24.64} x 7.3 {18.54}
Aspect Ratio [width:height]		4:3
Pixel Number [1 pixel is RGB trio]		XGA: 1,024 x 768px
Colour		16.7M colours [24-bit RGB]
Grey Scale		256 [8-bit Greyscale]
Backlight Luminance [LED type; approx.; adjustable] (cdm ⁻²) ¹	minimum	< 0.2
	maximum	>1000 (typ)
Contrast Ratio [limiting; LCD]		approx 1000:1
Response Time [typical] (ms)		23 [T _r =6; T _f = 17] @ 25°C
Readability [ambient conditions]		black-out to full direct sunlight [10 ⁵ lux]
Night Vision Device compatible?		yes [low intensity green; red selectable]
Viewing Angle [full angle] (°)	vertical	±80
	horizontal	±80

¹ 1 cdm⁻² = 1 nit.

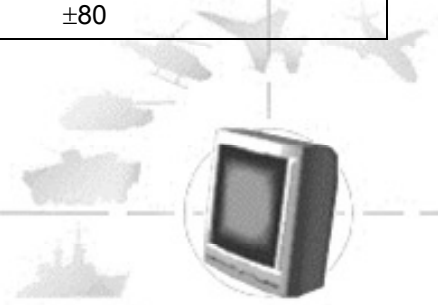

Product Specification

Black Opal R12 R Series Flat Panel Display System

PARAMETER		SPECIFICATION
Video IO		
Physical Connections		1~4 channels of CVBS input, 1 channel of CVBS output.
Signal Formats supported		Standard definition (SD) only: (PAL/NTSC/SECAM/CCIR-601/RS170)
Connection Formats		CVBS, 75ohm terminated
(Optional) Integral Recorder & Computer IO		
	Video Recorder	1x USB 2.0 Type A Host Mounted in a sealed D38999 Receptacle located on the bottom right corner of the front bezel. 1x Gigabit Ethernet RJ-45 Mounted in a downward facing sealed D38999.
Physical Connections	x86 Processor	Up to 2x USB 3.0 Hosts Mounted in a separate downward facing sealed D38999 Receptacles located on the rear of the chassis. One for a Boot Volume, one for Mass Storage. Up to 3x USB 2.0 Hosts Side & facing, mounted between mechanical mounting positions to fasten peripheral chassis. 1x Gigabit Ethernet RJ-45 Mounted in a downward facing sealed D38999.
Safety		
Cooling		thermal transfer by internal and external convection
Display Window		Antireflection, hard-coated, sealed, EMI/EMC shielded; index-matched to LCD glass. Optional resistive touch-screen.
Electrical Protection		conforms to: MIL-STD-704F; MIL-STD-1275D; STANAG 3350 (all analogue video inputs)
Audible Emission [@ ≥ 10m]		nil
Support		
MTBF [100% duty cycle] (hours)	Ground Mobile [wheeled]	> 14,343 hrs @ 40°C
	Airborne Rotary Wing	> TBD
Operational Life (years)		10



Black Opal R12 R Series Flat Panel Display System

2.2 Communications

PARAMETER		SPECIFICATION
Ports		3 Serial ports (max)
Data	Format	1 x RS-422 and 1 x RS-232 standard, extra RS232 port available on request.
	Rate (Baud)	115200,n,8,1 standard, others available on request

2.3 Physical Characteristics

PARAMETER		SPECIFICATION
Mass [approx.; option dependant] (kg)		5.1kg
Dimensions	Width	304.5
	Height	291.5
	Depth (body)	62
Mounting		Rear, Side and Top Mounts – others available on request

2.4 Electrical Characteristics

PARAMETER		SPECIFICATION
Supply Voltage (Vdc) [MIL-STD-1275D]		12 to 32V DC
Current Drain, Basic Unit, 100% Backlight [@ 28Vdc, no x86] (A)	heater on	< 2.1A (~60W)
	heater off	< 0.7A (~20W)

2.5 Environmental

PARAMETER		SPECIFICATION	
Temperature (°C) Operate ² [MIL-STD-810F, Method 501.4; Method 502.4, Procedures I, II]	min. ³	-40	
	max. ⁴	long term	+55
		short term	+71
	Survive	min. ³	-40
max. ⁴		+71	

² When used in accordance with procedures in User's Manual.

³ Without wind-chill.

⁴ Without solar radiation.



Black Opal R12 R Series Flat Panel Display System

PARAMETER	SPECIFICATION
Thermal Shock [MIL-STD-810F, Method 503.4, Procedure II] (°C transfer in ≤ 1 minute)	-30 to +50
Vibration [MIL-STD-810F, Method 514.5, Procedure I, Category 20 ground vehicle wheeled and tracked]	spectra as per figure 514.5C-4; 5Hz to 1kHz; 4 hours per axis
Shock [MIL-STD-810F, Method 516.5, Procedure I]	40g, 11ms each direction each axis, sawtooth
Sealing [MIL-STD-810F, Method 512.4, Procedure I] ⁵	full immersion
Altitude/Low Pressure [transport; MIL-STD-810F, Method 500.4, Procedure I]	15,000 feet
EMI/EMC ^{5, 6}	MIL-STD-461D

2.6 Connector/Pin Details

Connectors are organised in two groups:

1. Standard connectors that include Video, Communications and Power
2. Processor/recorder/expansion connectors that host x86 Computer IO as well as any custom IO specified by the customer.

Several standard and low cost connector options exist for both groups, and depending on the commercial arrangement **any R12 connector can be customised to suit a particular application.**

The following table shows connector/pin details for standard models.

No.	Name	Pin Marking	Purpose	Notes for Harness	Comment
VIDEO: SD Video: Connector, MilSpec, Jam Nut, D38999/24WC35PB ⁷					
1	CH1_OUT	1	CVBS video out	Coax, 75Ω centre	video output, 75Ω
2	GND	2	Video output GND	Coax, 75Ω shield	
3	CH3_IN	3	CVBS Channel 3 video in	Coax, 75Ω centre	video input, 75Ω
4	GND	4	Channel 3 input GND	Coax, 75Ω shield	
5	CH2_IN	5	CVBS Channel 2 video in	Coax, 75Ω centre	video input, 75Ω
6	GND	6	Channel 2 input GND	Coax, 75Ω shield	
7	CH1_IN	7	CVBS Channel 1 video in	Coax, 75Ω centre	video input, 75Ω
8	GND	8	Channel 1 input GND	Coax, 75Ω shield	
9	N/C	9			
10	N/C	10			
11	N/C	11			

⁵ With compliant line connectors attached.

⁶ Refer to manufacturer for details.

⁷ SD Video Connector pin details shown for standard model.

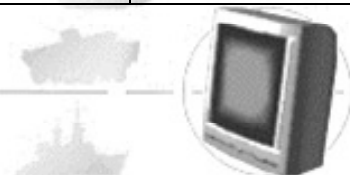

Black Opal R12 R Series Flat Panel Display System

No.	Name	Pin Marking	Purpose	Notes for Harness	Comment
12	N/C	12			
13	N/C	13			
14	N/C	14			
15	N/C	15			
16	N/C	16			
17	N/C	17			
18	N/C	18			
19	N/C	19			
20	N/C	20			
21	N/C	21			
22	N/C	22			
COMMS: Comms Connection: Connector, MilSpec, D38999/24WB35PB					
1	RS-232 TX	1	RS-232 transmit	signal	output
2	RS-232 RX	2	RS-232 receive	signal	input
3	RS-232 GND	3	Comms GND	signal	
4	RS-422 TX+	4	RS-422 transmit	signal	output
5	RS-422 TX-	5	RS-422 transmit	signal	output
6	RS-422 RX+	6	RS-422 receive	signal	input
7	RS-422 RX-	7	RS-422 receive	signal	input
8	RS-422 GND	8	RS-422 shield	signal	
9	(factory use only)	9	Ethernet transmit	signal	Upgrade port
10	(factory use only)	10	Ethernet transmit	signal	Upgrade port
11	(factory use only)	11	Ethernet receive	signal	Upgrade port
12	(factory use only)	12	Ethernet receive	signal	Upgrade port
13	GND	13		signal	
POWER: Power Input: Connector, MilSpec, D38999/24WB98PN					
1	V+	A	Input power (+28V) for display	6A dc (peak)	12..36V input
2	V-	B	dc- (GND) connection	6A dc (peak)	Isolated from chassis
3	V+	C	Input power (+28V) for display	Redundant	12..36V input
4	V-	D	dc- (GND) connection	Redundant	Isolated from chassis
GBE_0: Gigabit Ethernet RJ45 (Optional), Mating Connector: Amphenol RJFTV6 (D38999 Series III)					
As per 802.3ab Standard (as part of Embedded Recorder, or an Embedded x86 option)					

Black Opal R12 R Series Flat Panel Display System

No.	Name	Pin Marking	Purpose	Notes for Harness	Comment
	USB3_1 or USB2_1: USB Type A (Optional), Mating Con. Amphenol USBFTV6 (D38999 Series III)				
	As per USB 3.0, or USB 2.0, depending on the option selected (as part of Embedded Recorder, or an Embedded x86 option)				
	USB3_0 or USB2_0: USB Type A (Optional), Mating Con. Amphenol USBFTV6 (D38999 Series III)				
	As per USB 3.0, or USB 2.0, depending on the option selected (as part of Embedded Recorder, or an Embedded x86 option)				

Note: For EMI/EMC compliance, the cables that run to *each connector* MUST have a high quality RF shield over all conductors, and this shield **must** be RF bonded to the connector shell. *This includes the power cable.* Additionally, a small ferrite ring clamped over the outside of each cable near the connector can reduce emissions, and may be required for compliance. The need for these will be installation dependent – and will only improve the EMI profile of the system, so are strongly recommended.

2.7 Embedded Customer Specified Circuits

Please contact the factory for consultation. The video processor supports a highly-flexible high pin-count interface for data or video that can be made available to customer-specified hardware.



Black Opal R12 R Series Flat Panel Display System

3 SET-UP

3.1 Mounts

Multiple fastening points allow use of shock absorbers or mounting hardware per the customer's preference. Please note that all environmental and performance specifications (to MIL-STD-810F) are quoted, tested and qualified without shock absorbers fitted. Shock absorbers may be necessary where operation beyond parameters outlined in this document is required.

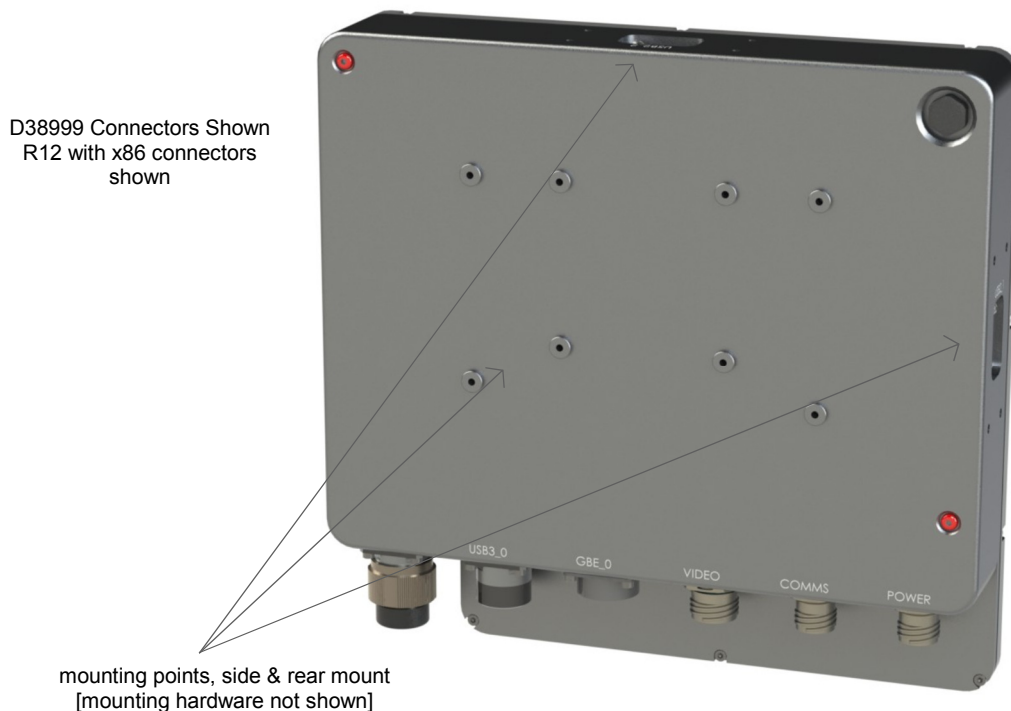

Figure 3-1: Mounts (R12 with x86 shown)

The unit has three mounting methods:

Rear mount;

- VESA 75mm
- Four M4 with stainless steel heli-coil inserts
- 6mm deep

Side mount;

- Four M6 per side with stainless steel heli-coil inserts
- 6mm deep
- 25mm and 75mm separation

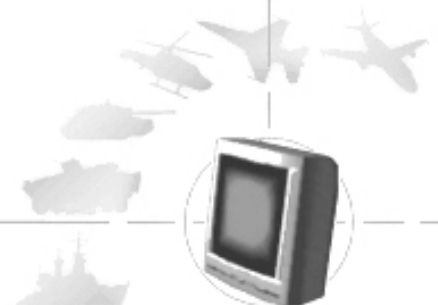

Black Opal R12 R Series Flat Panel Display System

Top mount;

- Four M6 at top with stainless steel heli-coil inserts
- 6mm deep
- 25mm and 75mm separation.

3.2 Connections

Standard units have three connection points located on the rear:

Power connection;

Comms connection; and

Video connection.

Optional connections shown here are:

Gigabit Ethernet RJ45 (for Embedded Recorder, or an Embedded x86 option);

USB3_1 or USB2_1: USB Type A (for Embedded Recorder, or an Embedded x86 option); and

USB3_0 or USB2_0: USB Type A (for Embedded Recorder, or an Embedded x86 option).



D38999 Connectors shown
R12 with x86 connectors shown

Figure 3-2: Connections (R12 with x86 shown)

3.3 Set-up Procedure

CAUTION: User-supplied cables must be correctly wired (see list of Connector/Pin Details).

Ensure that external power is within the range specified herein.

Ensure that external power is OFF before proceeding with set-up.

- Mount the unit to the vehicle or platform, using one of the mounting methods provided.
- Connect the required power cable to the unit and to the external power source.
- Connect the required data cable to the unit and to the communication data source.

Black Opal R12 R Series Flat Panel Display System

- Connect the required video cable to the unit and to the external imaging system(s).
- Connect any required cables for optional features (for Embedded Recorder, or an Embedded x86 option).

3.4 Heating and Cooling

The unit contains internal heating and cooling mechanisms that are triggered at certain internal temperatures.

The approximate warm-up rate is conservatively 20s/°C. Testing has shown that when starting at -40°C with no wind chill, this equates to a usable display in 5 minutes, subjectively good optical performance by 10 minutes and a display free from any degradation in approx. 20 minutes.

Once the unit has warmed it will operate normally provided that the ambient temperature stays within the specified operating temperature range. The operating procedures, internal temperatures and resulting operating conditions are shown in the following table.

Ambient Temp. (°C)	Procedure	Internal Temp. (°C)	Operating Condition
< -40	Shield from wind chill Remove any attached ice Cover display until usable	≤ 0	Heater on @ full power; performance not specified, operation not recommended.
-40 to 0	Shield from wind chill Remove any attached ice Cover the display until usable	≤ 0	Heater on @ full power; usable in 5 to 10 minutes
		> 0	Heater on @ low power; usable in < 5 minutes
0 to +55	none	≥ 10	Normal operation, heater off
		≥ 55	Reducing the backlight is recommended
+55 to +70	Keep display in shade provide forced air cooling (e.g. fan)		Reducing the backlight is recommended
> +70	Keep display in shade Provide forced air cooling	≥ 75	Performance not specified, operation not recommended.

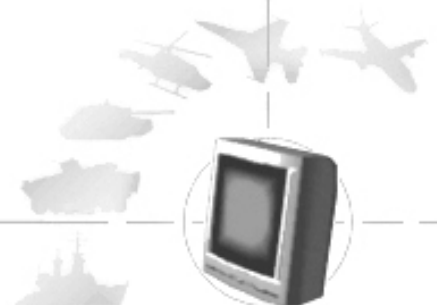

Product Specification

Black Opal R12 R Series Flat Panel Display System

4 OUTLINE DRAWING

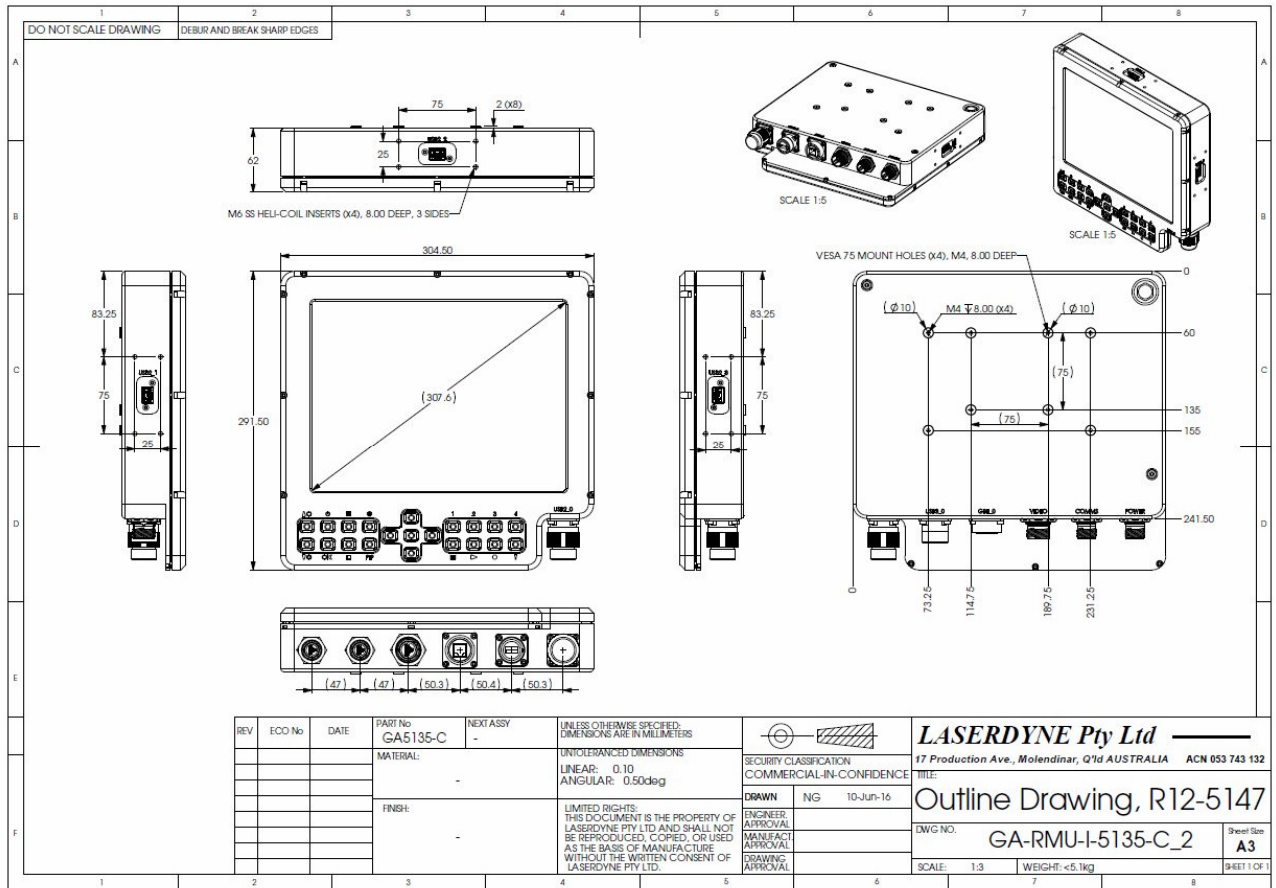

Figure 4-1: Outline Drawing (R12 with x86 shown)



A Division of Laserdyne Pty Ltd
A.C.N. 053 743 132

17 Production Ave
Molendinar
Queensland 4214
Australia

Tel: (07) 5594 9772 Int'l Tel: 61 7 5594 9772
Fax: (07) 5594 9981 Int'l Fax: 61 7 5594 9981

email: laserdyne@laserdyne.com.au
website: www.laserdyne.com.au

The information contained herein is proprietary to Laserdyne Pty Ltd. No part of this work may be reproduced or copied in any way without prior written permission of Laserdyne Pty Ltd.
Note: specifications herein are subject to change without notice.

Copyright. All Rights Reserved. Laserdyne Pty Ltd

File: PS-RMU-S-5147-E_1	Author(s): BS,TW,MW	Authorised: TW	Rev. Date: 14.06.16	Page 4-1
-------------------------	---------------------	----------------	---------------------	----------